

USER MANUAL **SPARKULAR® WAYER**

V1.1

2023/05/20



Showven Technologies Co., Ltd.

Thanks for choosing SPARKULAR® WAVER, we wish it will sparks up your show.
Please read the following manual carefully before operating this product.

Δ Safety Instructions

- ⚠ Unauthorized repair are prohibited, it may cause serious incident.
- ⚠ Please keep the device dry.
- ⚠ Make sure lid of feeding hopper are well covered when use SPARKULAR® WAVER.
- ⚠ Accidentally burning of consumable can only use sands to extinguish.
- ⚠ Consumable should keep away from moisture and stored in a dry sealed environment.
- ⚠ Check whether there is consumable aggregate in the output nozzle both before and after each show, if any, please clean it up, or it will affect the firing effect, damage machine, even cause serious incident.
- ⚠ There will be some sparks drop to ground, make sure there are no flammable objects such as carpet on the ground within the safety radius of the machine.
- ⚠ Suggest to use HC8200 MEDIUM for indoor events.
- ⚠ The SPARKULAR® WAVER power supply cable maximum allowed cascade of 6pcs (220V version) / 3pcs (110V version), exceed connecting may result in damage or even cause fire.
- ⚠ Cover the output nozzle of SPARKULAR® WAVER is forbidden, inspect the machine before each show, making sure no objects or material will block the output nozzle.
- ⚠ Never touch the nozzle of SPARKULAR® WAVER danger of getting burnt.
- ⚠ Never touch the sparks which shooting out from the nozzle.

Safety Distance

- ⚠ Safety distance for SPARKULAR® WAVER divided into two parts safety radius around machine (a) and safety distance at firing direction (b). No person and flammable materials are allowed to stay inside the safety isolation zone when SPARKULAR® WAVER was armed.
- ⚠ The safety radius around machine depends on effect height (consumable HC8200 type), with a radius of 1m or 1.5m.
- ⚠ For safety distance at firing direction equals to maximum firing height + 1m. SPARKULAR® WAVER with maximum $\pm 90^\circ$ waving firing angles, when firing wave sequence the safety isolation zone is a three-dimensional sector area.

HC8200 Type	Max. Effect Height	Safety Radius around SPARKULAR (a)	Safety Distance at Firing Direction (b)
Medium	3.5m	1m	4.5m
LARGE	4.5m	1.5m	5.5m

- ⚠ The SPARKULAR® WAVER safety isolation zone is a three-dimensional space with a cross-section of 180° sector enclosed by a and b (check below diagram). We can understand it as a safety area formed by a safety column with diameter of a, height of b rotate of ± 90 degrees. Unauthorized persons and objects are strictly prohibited from entering. Depending on the firing sequence / angles the sector area changes accordingly.
- ⚠ For angled firing, the safety distance both around machine and firing direction should shift accordingly.

- ⚠ In windy environment, increase the safety distance according to the wind direction and speed.
- ⚠ Sparks and consumables from the machine can lead to serious eye injury. Always wear safety goggles when enter the safety zone.

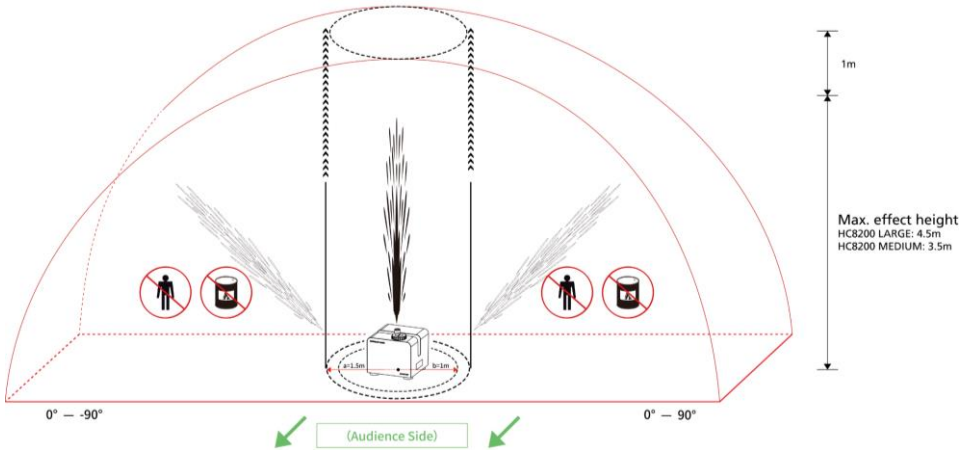

Δ Description

SPARKULAR® WAYER is 180 degree waving spark effect originally developed by SHOWVEN. It can firing in any single direction between -90 to 90 degree or in waving sequences etc. Various editable sparks effect brings infinite creativity to your stage.

Δ Technical Specifications

- ⚠ **DIMENSION:** 300×290×273mm
- ⚠ **WEIGHT:** 15.5kg
- ⚠ **VOLTAGE:** AC200-240V / AC100-120V, 50/60Hz
- ⚠ **WORK POWER:** 500W
- ⚠ **EFFECT HEIGHT ADJUSTBLE:** YES
- ⚠ **EFFECT ANGLE ADJUSTBLE:** -90°~ 90° (180° waving angles)
- ⚠ **INTERFACE:** 3-pin and 5-pin XLR, POWER IN/OUT
- ⚠ **CONTROL:** 6 DMX channels
- ⚠ **WORK TEMP.:** -20°C~40°C
- ⚠ **CONSUMABLE AND EFFECT HEIGHT:** LARGE (3-4.5m), MEDIUM (2.5-3.5m)

Δ Structure of SPARKULAR® WAYER

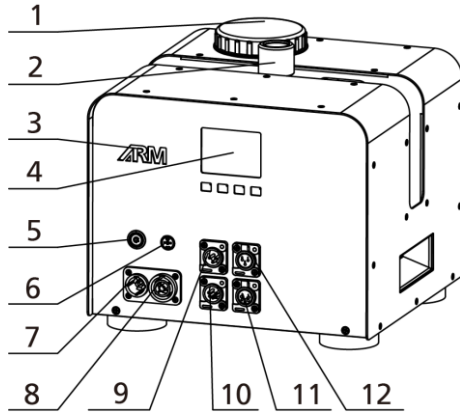

1. Feeding Hopper Lid
2. Output Nozzle
3. ARM alarming light
4. Display Screen
5. Power Switch
6. Fuse
7. Power IN
8. Power OUT
9. 3-PIN DMX IN
10. 5-PIN DMX IN
11. 5-PIN DMX OUT
12. 3-PIN DMX OUT

Bottom panel

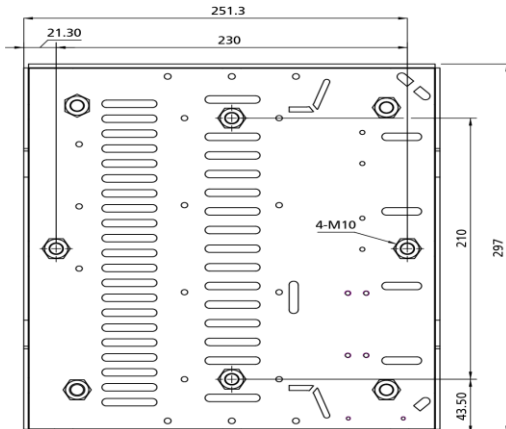

Δ Operation Panel

1. Keypad area



MENU: Press enter setting interface

UP: Parameter up

DOWN: Parameter down

MONI: Status monitoring of main part inside machine

2. Monitoring Interface

From this interface, we can check the voltage and motor status of machine.

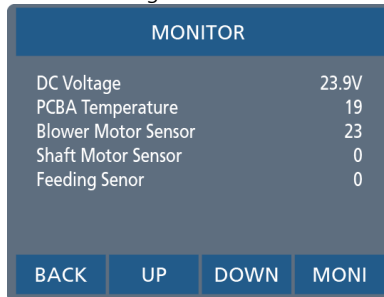

3. RFID area

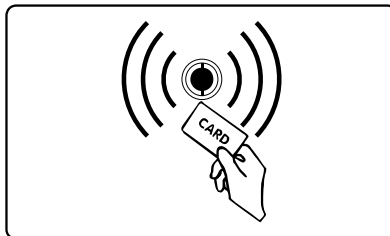

RFID card come with consumable HC8200 bags, swiping card to identify parameters and types of granules. The RFID card is disposable, one card can only use one time. Each card can increase

single machine 20min working time, the maximum recharge time for SPARKULAR® WAVER is 30min.

4. ARM alarming light



ON: DMX connected or wireless remote function ON.

BLINK: DMX armed, ready for firing

OFF: No DMX connection and wireless remote function OFF.

Δ Display Interface

1. Main Interface:

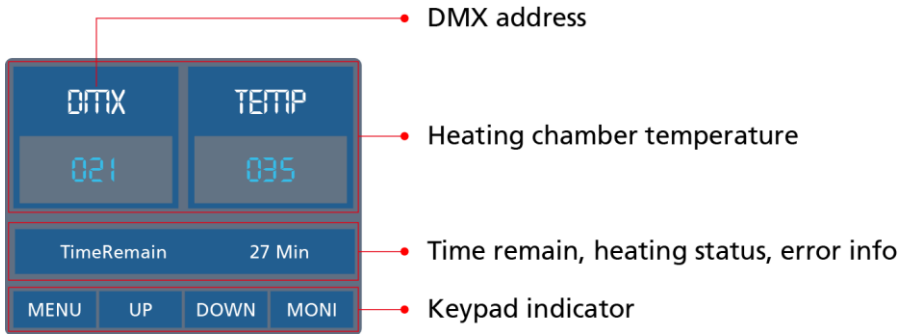

Background color of DMX area: red means DMX connected.

Background color of TEMP area: red means heating chamber temp. reached setting temp. machine is ready for firing.

Indicator light status on power switch: flash means machine is heating up, long on means temp. reached setting temp.

2. Error information

Error information	Explanation
E0 System IC	Systematic error
E1 Motor condition	Blower motor, shaft motor or feeding motor error
E2 Temp. Sensor	Temperature sensor is not connected or damaged
E3 P Temp. Over	Machine shutdown due to chassis over temperature
E4 Time Remain	Firing time is insufficient, please swipe RFID card
E5 K Temp. Over	Machine shutdown due to heating chamber over temperature

E6 Heat Fail	Heating fail, problem on heating PCB or mainboard
E7 Tip Over	Tilt sensor activated when machine slant over 45 degrees

3. Set Up Menu

Press "MENU" enter setup menu, press LEFT, RIGHT to choose main menu, advanced menu or factory menu. Press "EIDT" can entering related menu and setting up related parameters.

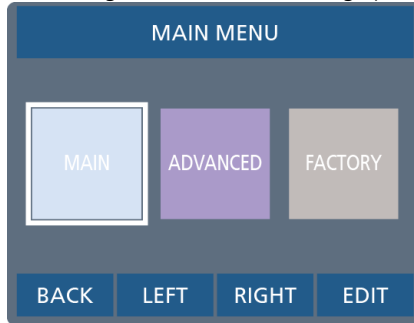

4. Main Menu

Parameters in main menu show in below table, press "UP"/ "DOWN" to change the value, please remember to press "SAVE" to save the setting.

Options	Range	Default	Explanation
Set DMX Address	1-512	1	Set DMX Address
Manual Heat	ON/OFF	OFF	Manual heat ON/OFF setting
Manual Fountain	ON/OFF	OFF	Manual Fountain ON/OFF setting
Sequence	2 - 72	2	Preset sequence setting
Max. Angle	-90°~90°	-90°	Max. Angle limit
Min. Angle	-90°~90°	90°	Min. Angle limit
Invert	ON/OFF	OFF	When turned on, all angles will be mirrored.
Head to middle	ON/OFF	ON	When ON and Channel 1 DMX value is 0, output nozzle will back to middle position after running a preset sequence.

5. Advanced Menu

Options	Range	Default	Explanation
Set Temperature	500-620	580	Setup SPARKULAR [®] heat chamber temperature
Auto Clear Delay	0.1-0.9s	0.1s	Automatic clear material time setting
Wireless 2.4G	ON/OFF	OFF	2.4G wireless function setting
LCD Backlight	ON/OFF	ON	LCD backlight setting

Density	50-100	100	Feeding amount
Mode Selection	Factory Mode User Mode	User Mode	Factory mode is for engineer only. When in Factory mode machine can't controlled by DMX console
Default Parameter	ON/OFF	OFF	Parameters reset to default setting
Motor Protect	ON/OFF	ON	Motor protect function
Tip Over	ON/OFF	ON	Tilt function switch, when machine slant over 45 degree it will stop working.
Standby Switch	ON/OFF	OFF	When ON, the machine can firing only when heating up was finished
Motor Disabled	ON/OFF	OFF	Motor can't waving when OFF
Key Sound	ON/OFF	ON	Keypad press sound setting

*For better performance of SPARKULAR[®] WAYER, please don't change the default value without permission from SHOWVEN[®].

6. DMX Channel Mode

SPARKULAR WAYER occupies 6 operational channels. First channel is for effect height, second channel for effect trigger and clear material etc.

Channel	Function	Value
CH1	Manual Angle setup	0~255: angle change from -90° to 90° 128: straight upward (0°)
CH2	Manual Nozzle Waving Speed setup	0 and 255: Max Speed 1~254: Speed increase
CH3	Firing ON/OFF	0~15: Firing OFF 16~90: Firing height low 91~170: Firing height medium 171~255: Firing height high Maxi. Single firing duration is 60s
CH4	n/a	Reserved
CH5	Preset sequence setup	0-2: no preset sequence 3-255: preset sequence DMX value = 2 + Sequence No.*2.55 (ROUND OFF)
CH6	Mode setup	0-49: Heating Up OFF (Emergency Stop) 50~200: Heating Up ON 201~255: Heating Up OFF (Emergency Stop)

Channel 1 (CH1): Manual Angle Setup

SPARKULAR WAYER output nozzle can be stayed at any angle between -90° to 90°, below is a list of typical angles used in our preset sequence with related DMX value.

Angle No.	Angle	DMX value
-----------	-------	-----------

1	90°	5
2	75°	24
3	60°	47
4	45°	66
5	30°	85
6	15°	108
7	0°	128 or 0
8	-15°	148
9	-30°	169
10	-45°	190
11	-60°	213
12	-75°	234
13	-90°	255

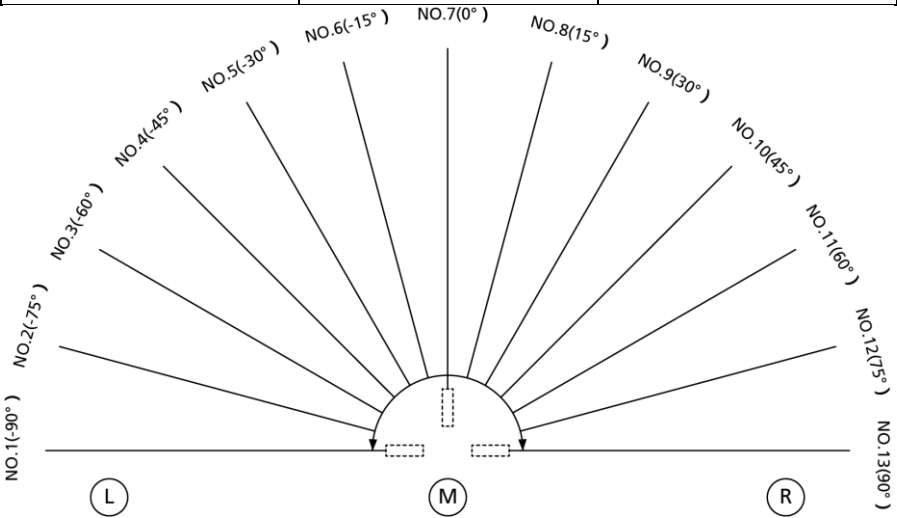

7. Firing Sequence

SPARKULAR WAVER has 72 preset sequences, operator use related channel DMX value or sequence No. to access certain sequence. Below, you can find sequence list.

No.	Ignition angle	Description	Firing Duration	CH5 DMX Reference Value
1	Any angle	Clear material	Depends on CH3	3-5
2	-90°	Fixed angle firing	Depends on CH3	6-7
3	-75°	Fixed angle firing	Depends on CH3	8-10
4	-60°	Fixed angle firing	Depends on CH3	11-12
5	-45°	Fixed angle firing	Depends on CH3	13-15

6	-30°	Fixed angle firing	Depends on CH3	16-17
7	-15°	Fixed angle firing	Depends on CH3	18-20
8	0°	Fixed angle firing	Depends on CH3	21-22
9	15°	Fixed angle firing	Depends on CH3	23-25
10	30°	Fixed angle firing	Depends on CH3	26-28
11	45°	Fixed angle firing	Depends on CH3	29-30
12	60°	Fixed angle firing	Depends on CH3	31-33
13	75°	Fixed angle firing	Depends on CH3	34-35
14	90°	Fixed angle firing	Depends on CH3	36-38
15	(-90°) ~ 90°	Slow waving once	8s	39-40
16	90° ~ (-90°)	Slow waving once	8s	41-43
17	(-90°)~ 90° ~(-90°)	Slow waving once	14s	44-45
18	(-75°)~ 75° ~ (-75°)	Slow waving once	12s	46-48
19	(-60°)~ 60° ~ (-60°)	Slow waving once	10s	49-50
20	(-45°)~ 45° ~ (-45°)	Slow waving 3 times	17s	51-53
21	(-30°)~ 30° ~ (-30°)	Slow waving 3 times	12s	54-56
22	(-15°)~ 15° ~ (-15°)	Slow waving 3 times	7s	57-58
23	(-90°)~ 90° ~ (-90°)	Medium waving 5 times	12s	59-61
24	(-75°)~ 75° ~ (-75°)	Medium waving 5 times	10s	62-63
25	(-60°)~ 60° ~ (-60°)	Medium waving 5 times	8s	64-66
26	(-45°)~ 45° ~ (-45°)	Medium waving 5 times	7s	67-68
27	(-30°)~ 30° ~ (-30°)	Medium waving 5 times	5s	69-71
28	(-15°)~ 15° ~ (-15°)	Medium waving 5 times	3s	72-73
29	(-60°)~ 60° ~ (-60°)	Fast waving 10 times	5s	74-76
30	(-45°)~ 45° ~ (-45°)	Fast waving 10 times	5s	77-79
31	(-30°)~ 30° ~ (-30°)	Fast waving 10 times	4s	80-81
32	(-15°)~ 15° ~ (-15°)	Fast waving 10 times	3s	82-84
33	(-75°)~ 0° ~ (-75°)	Fast waving 10 times	4s	85-86
34	(-60°)~ 0° ~ (-60°)	Fast waving 10 times	3s	87-89
35	(-45°)~ 0° ~ (-45°)	Fast waving 10 times	2s	90-91
36	(-30°)~ 0° ~ (-30°)	Fast waving 10 times	2s	92-94
37	75° ~ 0° ~ 75°	Fast waving 10 times	5s	95-96
38	60° ~ 0° ~ 60°	Fast waving 10 times	4s	97-99
39	45° ~ 0° ~ 45°	Fast waving 10 times	3s	100-101
40	30° ~ 0° ~ 30°	Fast waving 10 times	3s	102-104
41	(-90°)~ 0° ~ (-90°)	Slow waving twice	11s	105-107
42	(-75°)~ 0° ~ (-75°)	Slow waving twice	10s	108-109
43	(-60°)~ 0° ~ (-60°)	Slow waving twice	8s	110-112
44	(-45°)~ 0° ~ (-45°)	Slow waving twice	6s	113-114
45	(-30°)~ 0° ~ (-30°)	Slow waving twice	5s	115-117
46	90° ~ 0° ~ 90°	Slow waving twice	11s	118-119
47	75° ~ 0° ~ 75°	Slow waving twice	10s	120-122
48	60° ~ 0° ~ 60°	Slow waving twice	8s	123-124
49	45° ~ 0° ~ 45°	Slow waving twice	6s	125-127
50	30° ~ 0° ~ 30°	Slow waving twice	5s	128-130
51	(-90°)~ 0° ~ (-90°)	Medium waving 5 times	7s	131-132
52	(-75°)~ 0° ~ (-75°)	Medium waving 5 times	6s	133-135
53	(-60°)~ 0° ~ (-60°)	Medium waving 5 times	5s	136-137

54	(-45°)~ 0° ~ (-45°)	Medium waving 5 times	4s	138-140
55	(-30°)~ 0° ~ (-30°)	Medium waving 5 times	3s	141-142
56	90° ~ 0° ~ 90°	Medium waving 5 times	7s	143-145
57	75° ~ 0° ~ 75°	Medium waving 5 times	6s	146-147
58	60° ~ 0° ~ 60°	Medium waving 5 times	5s	148-150
59	45° ~ 0° ~ 45°	Medium waving 5 times	4s	151-152
60	30° ~ 0° ~ 30°	Medium waving 5 times	3s	153-155
61	90° ~ 45° ~ 90°	Slow waving 3 times	10s	156-158
62	90° ~ 30° ~ 90°	Slow waving 3 times	13s	159-160
63	(-90°) ~ (-45°) ~ (-90°)	Slow waving 3 times	10s	161-163
64	(-90°) ~ (-30°) ~ (-90°)	Slow waving 3 times	12s	164-165
65	(-90°) ~ 0°	Slow waving gradually decreases angle	18s	166-168
66	90° ~ 0°	Slow waving gradually decreases angle	19s	169-170
67	(-90°) ~ 90°	Slow waving gradually decreases angle	41s	171-173
68	0° ~ (-90°)	Slow waving once	5s	174-175
69	(-90°) ~ 0°	Slow waving once	5s	176-178
70	0° ~ 90°	Slow waving once	5s	179-180
71	90° ~ 0°	Slow waving once	5s	181-183
72	0°	Fixed angle firing	Depends on CH3	184-185

DMX control example 1: firing sequence No. 42

1. Set output nozzle straight up

CH1 = 128, CH2 = 0, CH3 = 0, CH4 = 0, CH5 = 0, CH6 = 128

2. Set preset Sequence No. 42

CH1 = 128, CH2 = 0, CH3 = 0, CH4 = 0, CH5 = 108, CH6 = 128

3. Firing 1s

CH1 = 128, CH2 = 0, CH3 = 255, CH4 = 0, CH5 = 108, CH6 = 128

DMX control example 2: firing sequence No. 8, firing time 10s

1. Set output nozzle straight up

CH1 = 128, CH2 = 0, CH3 = 0, CH4 = 0, CH5 = 0, CH6 = 128

2. Set preset Sequence No. 8

CH1 = 128, CH2 = 0, CH3 = 0, CH4 = 0, CH5 = 21, CH6 = 128

3. Firing

CH1 = 128, CH2 = 0, CH3 = 255, CH4 = 0, CH5 = 21, CH6 = 128

Keep 10s.

4. Firing OFF

CH1 = 128, CH2 = 0, CH3 = 0, CH4 = 0, CH5 = 0, CH6 = 128

8. Wireless Control Mode:

When use remote controller, please disconnect DMX cable connection, set machine to Wireless 2.4G to ON status. Match machine with remote controller by Press "A" on remote controller when machine at Wireless Control interface.

A: OFF / SET, Firing OFF, SET means match machine with remote controller.

B: Firing, vertical up (0°)

C: Firing, according to the sequence setting on machine

D: Clear Material 3s.

Please replace the battery when the indicator light on remote controller is weak.

Battery mode: 9V stacked battery.

Remote controller for SPARKULAR WAYER is optional accessory.



Δ Operation Guide

1. Install SPARKULAR®WAYER

- a) SPARKULAR® WAYER can only be installed horizontally.
- b) Make sure the machine is securely installed to avoid tipping.
- c) Check carefully the output nozzle of each machine, make sure the output nozzle is in good shape and there is no powder aggregate.

2. Fill SPARKULAR® WAYER

- a) Open powder bags and fill the feeding hopper.
- b) Choose correct consumable according to the application scenario. SPARKULAR® WAYER can only use HC8200 LARGE and MEDIUM.
- c) Please be noted that there may sparks or remains fall to the ground. Make sure no flammable material on ground in the safety zone.
- d) Maximum effect height: HC8200 LARGE is 4.5m, HC8200 MEDIUM is 3.5m.
- e) Make sure the lid of hopper is locked tight after filling.

3. Connect Power / DMX cable

- a) Connect a power cable to the POWER IN socket of SPARKULAR® WAYER. Connect the other end of power cable to the power source. Make sure power supply in consistent with the rated voltage of the equipment, and the socket must well grounded.
- b) If connect machine in sequence, please connect a power link cable to the POWER OUT of previous machine, connect the other end of the power link cable to POWER IN of the next machine.
- c) The SPARKULAR® WAYER power supply cable maximum allowed cascade is 6 units (220V version) / 3pcs (110V version). Do not connect exceed units to a single electrical circuit.
- d) Power ON all SPARKULAR® WAYER.
- e) Assign DMX address for each unit of SPARKULAR® WAYER. If use SHOWVEN host controller or FXcommander to control the machine please allocate a unique DMX address for each unit of machine.

If use remote controller to control SPARKULAR® WAVER wirelessly, please set machine to wireless ON status and match machine with remote controller. For DMX cable control please execute below operations (f to h).

- f) Connect a DMX cable to the DMX IN socket of first unit of SPARKULAR® WAVER, connect the male connector end of DMX cable to your DMX controller (FXcommander, HOST CONTROLLER, light console etc).
- g) Connect a DMX cable to the DMX OUT of previous machine, and the other end of to the DMX IN of next machine. Connect all devices in series in this way.
- h) Suggest to plug in a DMX terminator into the DMX OUT in last unit of machine to improve signal reliability. Signal amplifier is required for long distance (>200m) DMX signal transmission (SHOWVEN DMX splitter 8 with bidirectional signal transmission, thus can get signal feedback from device).

4. Activate SPARKULAR® WAVER by swipe RFID card

- a) Swipe an RFID card. Read the card as show below. SPARKULAR® WAVER shows time remain if read successfully. SPARKULAR® WAVER report E4 when remaining time is less than 10 minutes.
- b) Please note each RFID card come with 200g package HC8200 can increase single machine 20min working time, the maximum recharge time for SPARKULAR® WAVER is 30min, when time remain reached 30min, it can't recharge anymore RFID card.

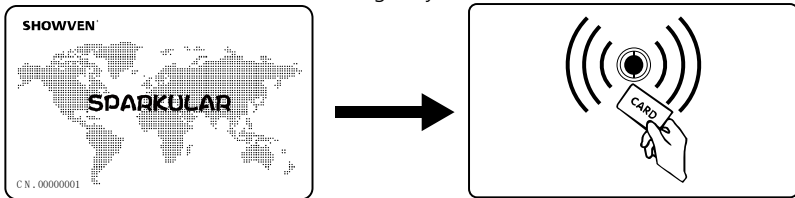

5. Programming and Firing

- a) Programming SPARKULAR® WAVER, set the firing sequences etc.
- b) Heating up, it takes around 5min, it varies according to the voltage and environment temperature.
- c) Make sure the prescribed safety zone of related firing sequences are clear.
- d) Suggest to clear material before firing.
- e) Firing. In order to prevent overheat in the heating chamber and protect machine, the maximum continuous firing time for SPARKULAR® WAVER is 60s.
- f) The operator should always have a clear view of the device, so that he/she can stop the show immediately when there is danger.
- g) Running preset sequence No.1 to clear material for SPARKULAR® WAVER after show, clear material will remove the remaining particles from heating chamber.

NOTE:

If use SHOWVEN HOST CONTROLLER ZK6200/6300 to control the firing, please press "F3" to choose "CIRCLE FLAMER-6CH", then set the firing sequence, as for preset sequence the firing duration is fixed, so please set

firing duration 1s. Please do allocate different DMX address for each unit of SPARKULAR WAYER (6 channels), otherwise it will cause signal interference.

6. Turn Off and clean up

- a) Power off SPARKULAR® WAYER, allow SPARKULAR® WAYER to cool down.
- b) Disconnect all POWER and DMX cables.
- c) Empty the remaining HC8200 in hopper, and store the remaining HC8200 in a dry sealed bottle for next time use. Never touch the output nozzle of SPARKULAR® WAYER when empty the hopper. DANGER OF GET BURNT!
- d) Operators can use handheld vacuum cleaner to empty the feeding hopper. Do make sure the machine was cool down when clean it. Do NOT use high-power vacuum cleaners to avoid hot consumables being sucked into the vacuum cleaner from the heating chamber and cause fire.
- e) Clean the surroundings to remove powder residues.

Δ **Maintenance**

- a) Empty the feeding hopper before shipment of machine.
- b) Empty the feeding hopper if long time not use, for high humidity environment we suggest to empty feeding hopper after each show.
- c) Clear material both before and after the show.

Δ **Warranty Instructions**

- \ Sincere thanks for your choosing our products, you will receive quality service from us
- \ The product warranty period is one year. If there are any quality problems within 7 days after shipping out from our factory, we can exchange a brand new same model machine for you
- \ We will offer free of charge maintenance service for machines which with hardware malfunction (except for the instrument damage caused by human factors) in warranty period. Please don't repair machine without factory permission

Below situations NOT included in warranty service:

- \ Damage caused by use other type of consumable which is not from SHOWVEN® or SHOWVEN® authorized distributor.
- \ Damage caused by improper transportation, usage, management, and maintenance, or damage caused by human factors;
- \ Disassemble, modify or repair products without permission;
- \ Damage caused by external reasons (lightning strike, power supply etc.)
- \ Damage caused by improper installation or use;

For product damage not included in warranty range, we can provide paid service.

Invoice is necessary when applying for maintenance service from SHOWVEN®.

SHOWVEN[®]



Showven Technologies Co., Ltd.

Tel: +86-731-83833068

Web: www.showven.cn E-mail: info@showven.cn

Add: No.1 Tengda Road, Liuyang Economic & Technical Development Zone, 410300, Changsha, Hunan, P.R.China